

# PRESSURE SWITCHES

## Gas Pressure Switches

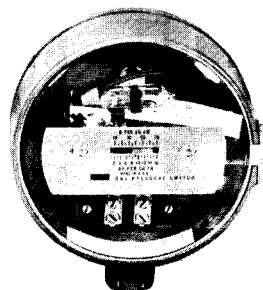

**Honeywell C437**—Pressure actuated for safety shut-off. The lock-out mechanism "trips free" after each resetting so that the lock-out occurs even if the reset button is held in. SPST. 1/2" internal N.P.T. mounting.

### BREAK ON PRESSURE RISE

<u>Cat. No.</u>	<u>Part No.</u>	<u>Range</u>	<u>Max.</u>	<u>Max. w/o Loss of Accuracy</u>
<b>Manual Reset</b>				
C437D-1005	16073	1-16oz.	5 lb.	2 lb.
C437D-1013	16119	.5-5 lb.	15 lb.	10 lb.

### **Automatic Reset**

C437G-1002	16925	1-16 oz.	5 lb.	2 lb.
------------	-------	----------	-------	-------

### BREAK ON PRESSURE FALL

### **Manual Reset**

C437E-1004	16072	1-16 oz.	5 lb.	2 lb.
C437E-1012	16118	.5-5 lb.	15 lb.	10 lb.
C437E-1020	CON	1-10 lb.	30 lb.	20 lb.

### **Automatic Reset**

C437H-1001	17132	1-16 oz.	5 lb.	2 lb.
C437H-1027	12654	.5-5 lb.	15 lb.	10 lb.
C437H-1035	12657	1-10 lb.	30 lb.	20 lb.
C437H-1043	14582	.5-5" w.c.	3 lb.	---

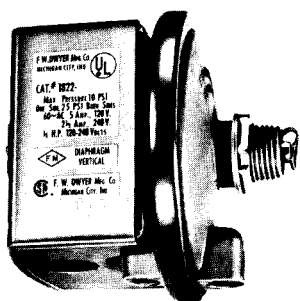
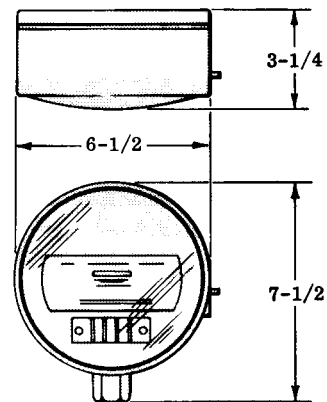

**Dwyer 1823-5**—Low differential pressure switch for general industrial service. Set point adjustment inside the mounting spud permits mounting switch on one side of a panel with adjustment easily accessible on the opposite side. UL and CSA listed, FM approved. Automatic reset, SPDT. 1/2" N.P.T. mounting spud, 1/8" pressure taps.

Range: 1.5" to 5.0" w.c.

Cat. No.: 1823-5

Part No.: 19235

Max. Pressure: 10 psig.

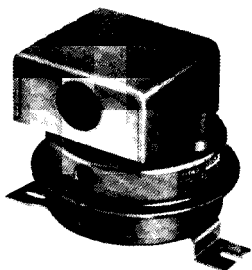
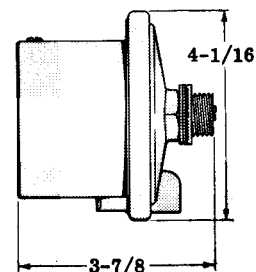

**Antunes SMDF 12C133**—Low pressure listed by UL for use with air. Will respond to a positive, negative, or differential pressure. SPDT. 3-2/3" dia., 3-1/4" high.

Range: 0.18" to 6.0" w.c.

Part No.: 14494

Max. Pressure: 36" w.c. surge.



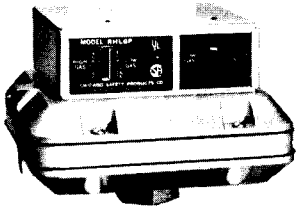

**Antunes RHLGP**—High/low gas pressure switches monitor pressure variations and operate a visible or audible alarm. Automatic recycle. SPDT. 3/8" internal N.P.T. mounting.

<u>Part No.</u>	<u>Low Pressure Range</u>	<u>High Pressure Range</u>
19725	1" to 6" w.c.	2" to 16" w.c.
16394	2" to 14" w.c.	5" to 28" w.c.
19727	6" to 24" w.c.	10" to 50" w.c.

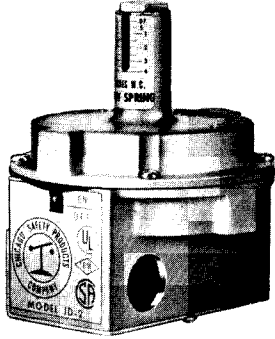
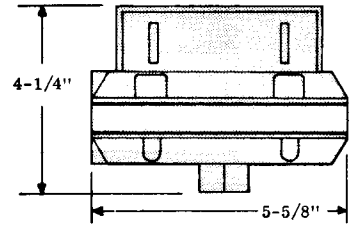

**Antunes JD-2**—Differential, vacuum or pressure switch. Max. pressure 3 psig. Max. temp. 140° F. 1/8" NPT taps.

<u>Part No.</u>	<u>Pressure Range</u>
16928	.07" to 4" w.c.
16928-1	0.1" to 24" w.c.

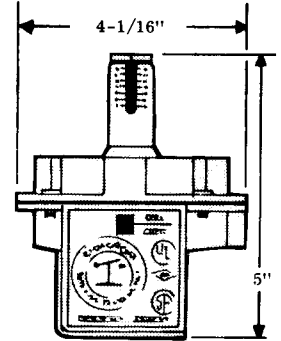

### Oil Pressure Switches

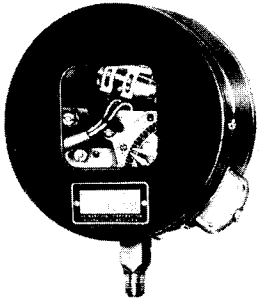

**Mercoid DAF**—Oil pressure supervisory switches for use with #6 or lighter fuel oil. Heavy gauge steel cases, NEMA 1. Double outside adjustment for individually setting high and low set points. Set points are indicated by pointers on a visible calibrated dial.

Electrical: 120 VAC or VDC, 10 amps; 240 VAC or VDC, 5 amps; 440 VAC, 3 amps. Motor rating: 120/240 VAC, 1 ph., 3/4HP SPST; or 1/2 HP multi-circuit for AC 1/3.

**BREAK ON PRESSURE RISE**

<u>Cat. No.</u>	<u>Part No.</u>	<u>Range</u>	<u>Max. Surge</u>	<u>Min. Diff.</u>
DAF-81-23K-2	CON	5-75 lb.	110 lb.	3 lb.
DAF-81-24K-2	18059	10-150 lb.	190 lb.	6 lb.

**MAKE ON PRESSURE RISE**

DAF-81-23K-3	16635	5-75 lb.	110 lb.	3 lb.
DAF-81-24K-3	CON	10-150 lb.	190 lb.	6 lb.

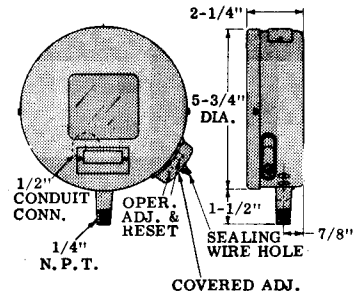

**ECLIPSE COMBUSTION**



**Offered By:**

Power Equipment Company  
2011 Williamsburg Road  
Richmond, Virginia 23231  
Phone (804) 236-3800  
Fax (804) 236-3882

---

[www.peconet.com](http://www.peconet.com)